



**STAND OUT FROM  
THE CROWD**



**Polaris 1 Hexagon**  
Linear LED Feature Pendant



# Polaris 1 Hexagon

## Linear LED Feature Pendant

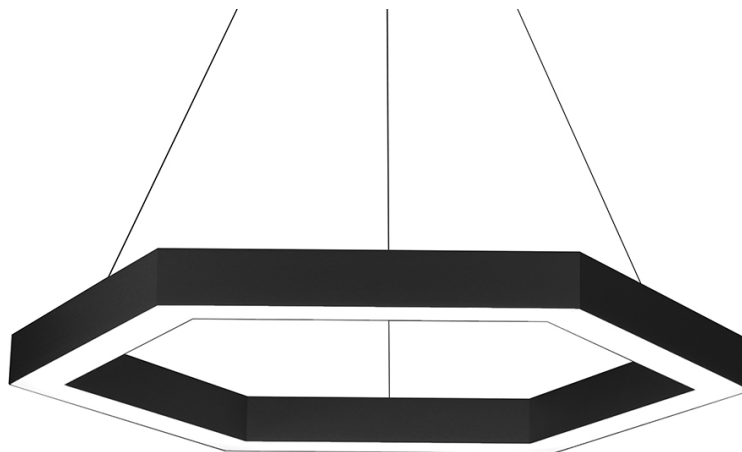

### SPECIFICATION DATA

Code	Weight	Size (mm)	Luminaire power (tcW)	Delivered Lumens (Llm)	Efficacy (lm/cw)	Colour Temp (°K)	CRI	Power Factor (TOP driver)
<b>P1HB/OS/F/0280/4K8</b>	8.1	6x280mm	47	5510	117.2	4000K	>80	0.95
<b>P1HB/OS/F/0580/4K8</b>	9.7	6x580mm	94	11020	117.2	4000K	>80	0.95
<b>P1HB/OS/F/0880/4K8</b>	11.2	6x880mm	140	16530	118.1	4000K	>80	0.95
<b>P1HB/OS/F/1160/4K8</b>	14.6	6x1160mm	187	22040	117.9	4000K	>80	0.95
<b>P1HB/HX/F/0280/4K8</b>	8.1	6x280mm	47	4240	90.2	4000K	>80	0.95
<b>P1HB/HX/F/0580/4K8</b>	9.7	6x580mm	94	8480	90.2	4000K	>80	0.95
<b>P1HB/HX/F/0880/4K8</b>	11.2	6x880mm	140	12720	90.9	4000K	>80	0.95
<b>P1HB/HX/F/1160/4K8</b>	14.6	6x1160mm	187	16960	90.7	4000K	>80	0.95

- 5 year warranty
- See website for LDT files
- MacAdam 3 Step
- Rated Life (hrs) : >60,000
- IP20



**TRIDONIC**



**Scenario**  
INTELLIGENT INFRASTRUCTURES



# Polaris 1 Hexagon

## Linear LED Feature Pendant



### Construction

- Extruded aluminium profile
- Clip-in diffuser
- European brand control gear
- Made in the UK

### Features

- High efficiency LED boards
- Range of length options
- Wide-beam light distribution

### Applications

- Commercial and Business Areas
- Public buildings
- Housing
- Offices
- Hotels and Restaurants
- Arts and Culture spaces

### Benefits

- Custom-fit options
- Contemporary style
- Energy efficient solution
- 5 Year warranty

### Optical Options

Code	Description
/OS	Opal
/HXP	Low Glare

### CCT Options

Code	Description
4K8	4000K (Standard)
3K8	3000K

For 3000K version, replace '4K8' in part number with '3K8'

### Control Options

Code	Description
D	DALI
S	Switchdim control

For DALI control, replace 'F' in part number with 'D' for SwitchDim replace 'F' with 'S'

### Dimensions

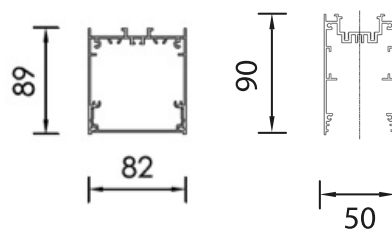

### Mounting Options

Code	Description
P1/SUS/1.25M	Suspended 1.25M
P1/SUS/3.0M	Suspended 3M
P1/SUS/5.0M	Suspended 5M

Surface Mounted (Standard)

For suspended specify the codes as required.

### Finish Options

Code	Description
B	Black RAL 9005 (Standard)
W	White RAL 9016
S	Silver RAL 9006
RAL	Any RAL by request
SFX	Special effect finishes (SFX) by request. See Product Portfolio

For White finish, replace 'B' in part number with 'W' for Silver replace 'B' with 'S'. Contact us for custom RAL and SFX finish prices

### Emergency Options

Code	Description
/EM	3 hour maintained, manual test
/ED	3 hour maintained, DALI / Self Test

For emergency version, add onto end of part number as required

### Continuous Options

Code	Description
C	Continuous
S	Start of run
E	End of run

Part numbers are for individual luminaires. For continuous replace 'I' in part number with 'C', 'S' or 'E'. Please specify continuous separately. ie **P1CB/OS/F/3990/4K8**

**Please note,** The light source contained in this luminaire shall only be replaced by the manufacturer or his service agent or a similar qualified person.

# Polaris 1 Hexagon

Linear LED Feature Pendant

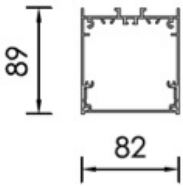
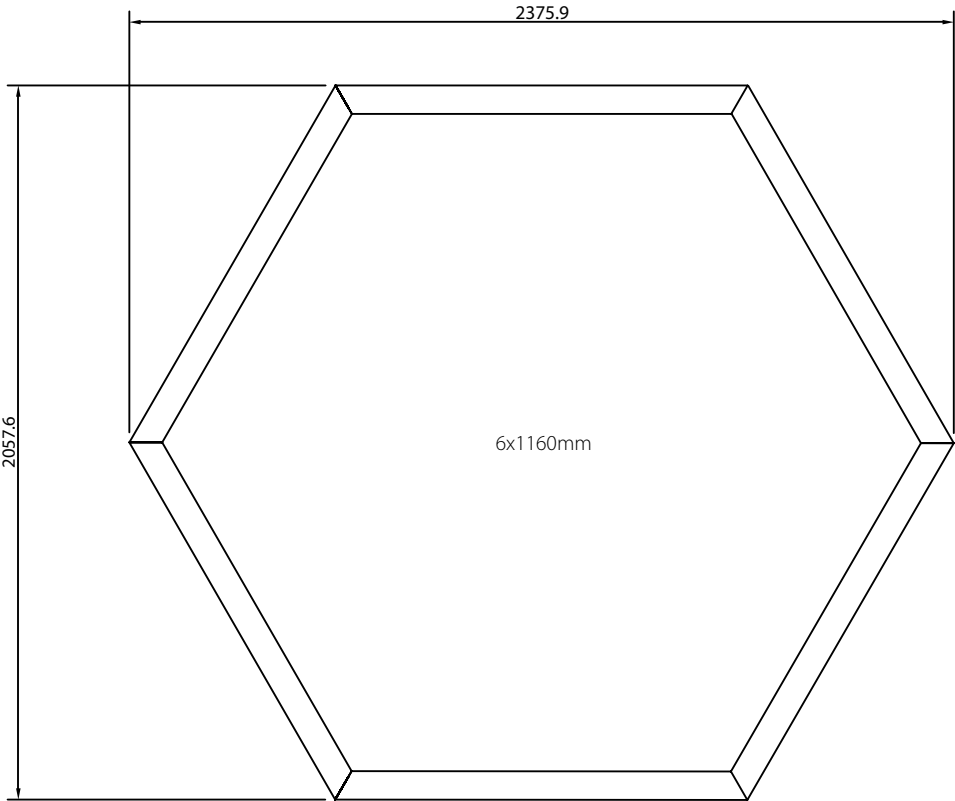
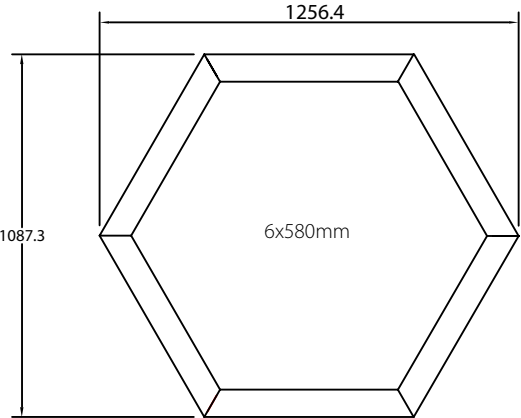
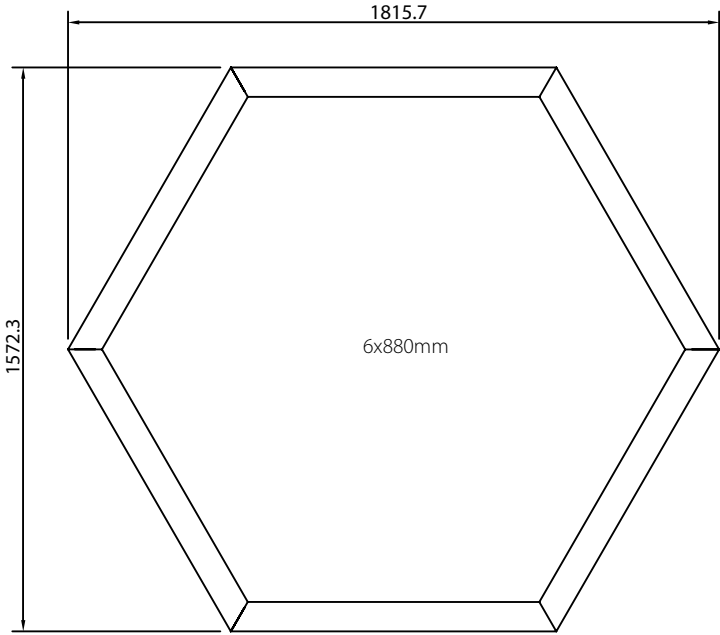
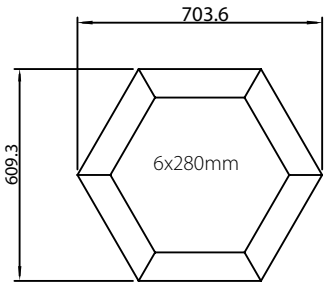

# Polaris 1 Hexagon

Linear LED Feature Pendant

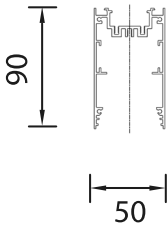
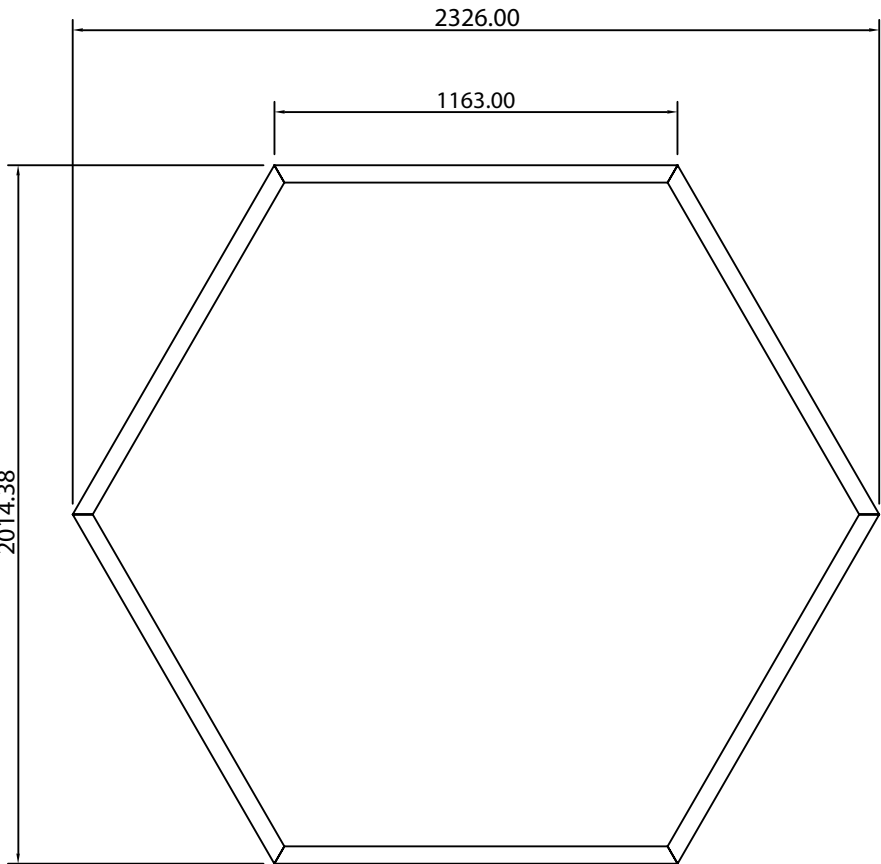
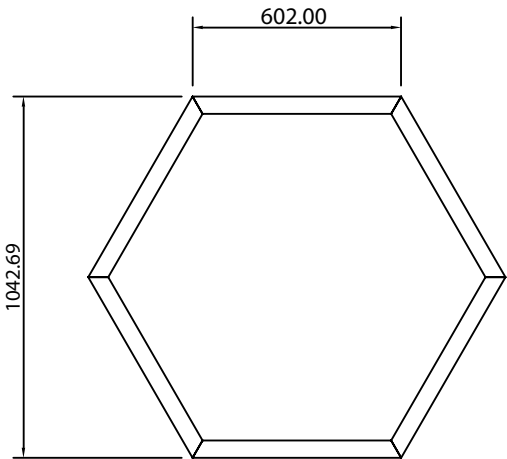
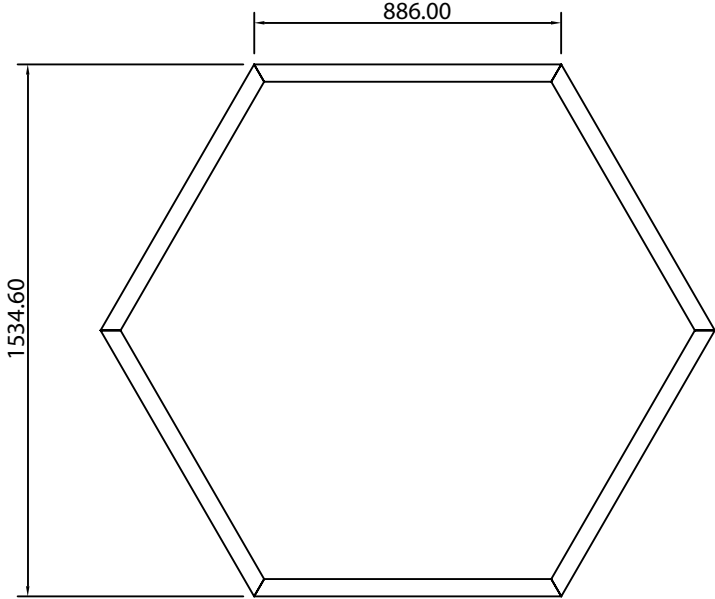
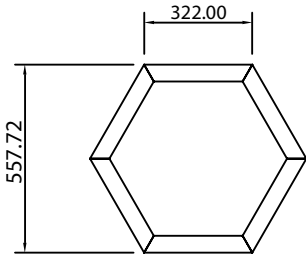

# Polaris 1 Hexagon

## Linear LED Feature Pendant



### STANDARD FINISHES

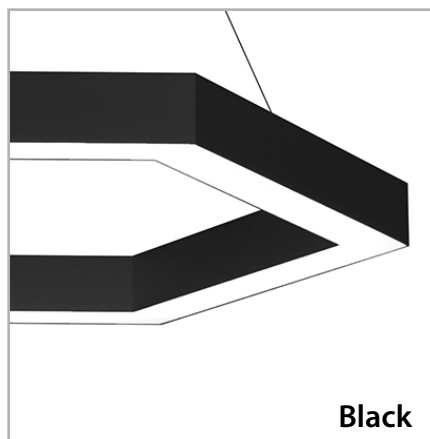

**Black**

Black finish as standard - represented by 'B' in the part number

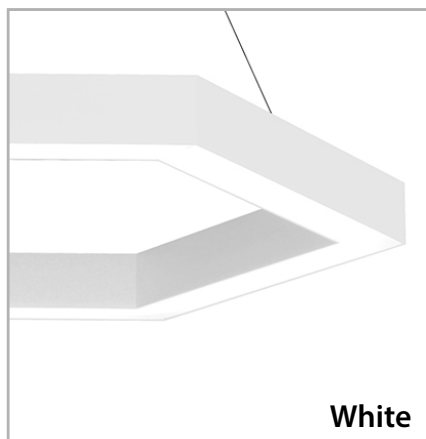

**White**

For White finish, replace 'B' in part number with 'W'

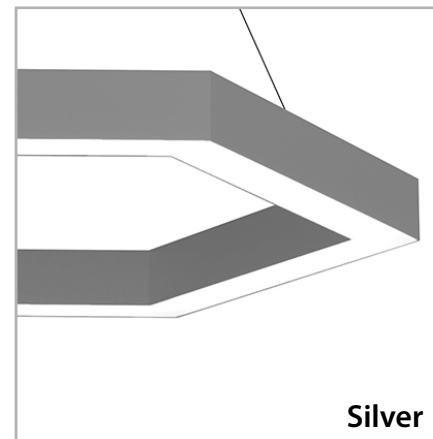

**Silver**

For Silver finish, replace 'B' in part number with 'S'

### ANY RAL BY REQUEST

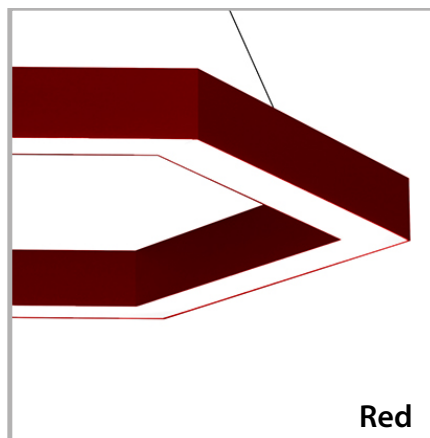

**Red**

Contact us for custom RAL finishes prices and specification. Synergy Creativ can powder coat fittings to any RAL colour you require by request.

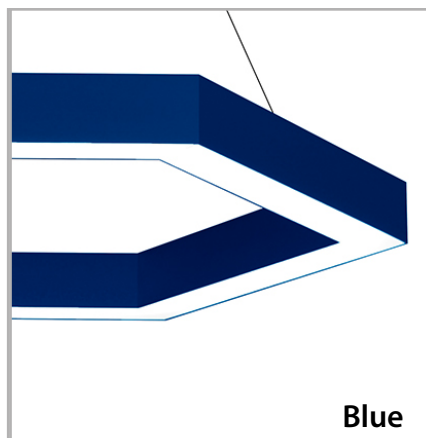

**Blue**

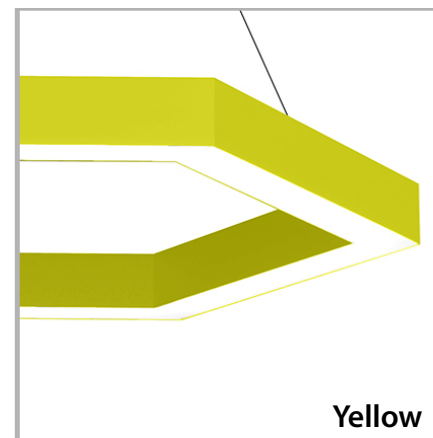

**Yellow**

### SPECIAL FX FINISHES

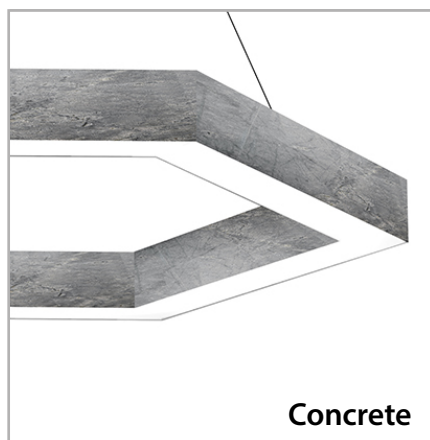

**Concrete**



**Wood Grain**

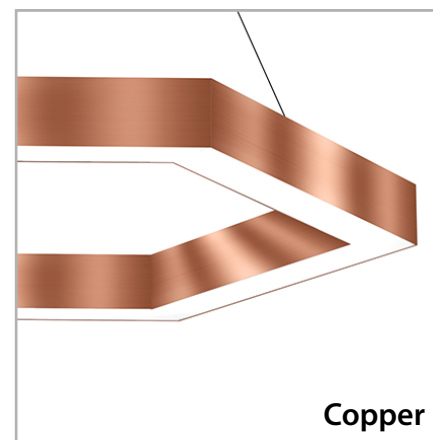

**Copper**

Contact us for all SFX finish prices and specification. Synergy Creativ's Special FX textured finishes include Marble, Concrete, Wood Grains, Metallic and many more. All images are for illustrative purposes only; actual product may vary, please contact us for samples.



**FULLY CUSTOMISABLE**  
**If you can  
imagine it  
Synergy Creativ  
can make it**

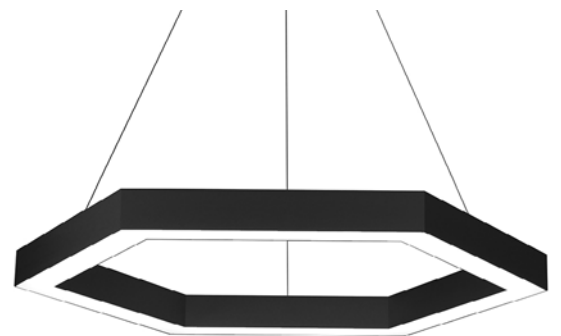
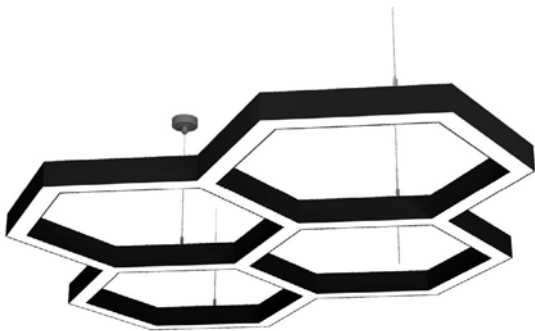

HEADOFFICE: Unit 5, Trident industrial Estate, Pindar Rd, Hoddesdon Hertfordshire, EN11 0WZ  
SHOWROOM: 121 - 131 Rosebery Ave, London, EC1R 4RF  
SHOWROOM: 1 New York St, Manchester, M1 4HD

**01992 445828**

