



**STAND OUT FROM
THE CROWD**



Polaris 1 Hexagon
Linear LED Feature Pendant



Polaris 1 Hexagon

Linear LED Feature Pendant

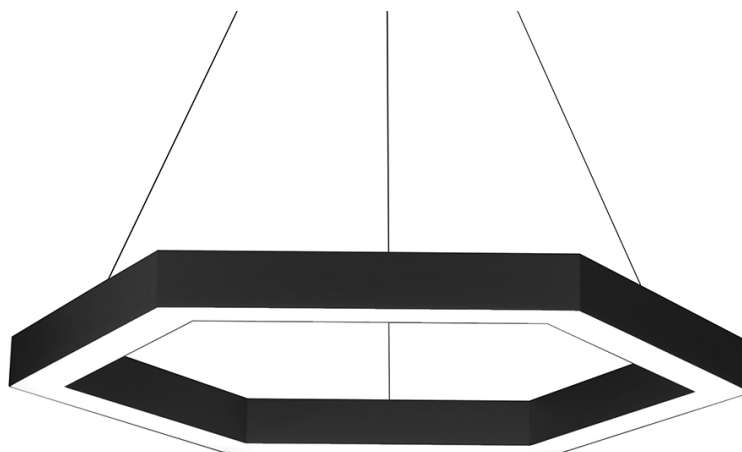

SPECIFICATION DATA

Code	Finish	Diffuser	Size (mm)	Delivered Lumens (lm)	Total System Wattage (W)	Efficacy (lm/cw)	Colour Temp (°K)	CRI
P1HB/OS/F/0280/4K8	Black	Opal	6x280mm	5510	47	117.2	4000K	>80
P1HB/OS/F/0580/4K8	Black	Opal	6x580mm	11020	94	117.2	4000K	>80
P1HB/OS/F/0880/4K8	Black	Opal	6x880mm	16530	140	118.1	4000K	>80
P1HB/OS/F/1160/4K8	Black	Opal	6x1160mm	22040	187	117.9	4000K	>80
P1HB/HX/F/0280/4K8	Black	Low Glare	6x280mm	4240	47	90.2	4000K	>80
P1HB/HX/F/0580/4K8	Black	Low Glare	6x580mm	8480	94	90.2	4000K	>80
P1HB/HX/F/0880/4K8	Black	Low Glare	6x880mm	12720	140	90.9	4000K	>80
P1HB/HX/F/1160/4K8	Black	Low Glare	6x1160mm	16960	187	90.7	4000K	>80

- Part numbers are for individual luminaires.
- 5 year warranty
- See website for LDT files
- For CAD/BIM contact us
- For bespoke lengths please contact us
- See website for Technical Data Sheet
- IP20
- Available in Polaris 1 and Polaris 50 profile



TRIDONIC



Scenario
INTELLIGENT INFRASTRUCTURES



Polaris 1 Hexagon

Linear LED Feature Pendant



Construction

- Extruded aluminium profile
- Clip-in diffuser
- European brand control gear
- Made in the UK

Features

- High efficiency LED boards
- Range of length options
- Wide-beam light distribution

Applications

- Commercial and Business Areas
- Public buildings
- Housing
- Offices
- Hotels and Restaurants
- Arts and Culture spaces

Benefits

- Custom-fit options
- Contemporary style
- Energy efficient solution
- 5 Year warranty

Optical Options

Code	Description
/OS	Opal
/HXP	Low Glare

CCT Options

Code	Description
4K8	4000K (Standard)
3K8	3000K

For 3000K version, replace '4K8' in part number with '3K8'

Control Options

Code	Description
D	DALI
S	Switchdim control

For DALI control, replace 'F' in part number with 'D' for SwitchDim replace 'F' with 'S'

Dimensions

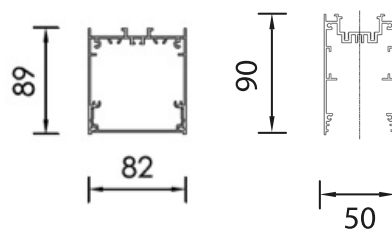

Mounting Options

Code	Description
P1/SUS/1.25M	Suspended 1.25M
P1/SUS/3.0M	Suspended 3M
P1/SUS/5.0M	Suspended 5M

Surface Mounted (Standard)

For suspended specify the codes as required.

Finish Options

Code	Description
B	Black RAL 9005 (Standard)
W	White RAL 9016
S	Silver RAL 9006
RAL	Any RAL by request
SFX	Special effect finishes (SFX) by request. See Product Portfolio

For White finish, replace 'B' in part number with 'W' for Silver replace 'B' with 'S'. Contact us for custom RAL and SFX finish prices

Emergency Options

Code	Description
/EM	3 hour maintained, manual test
/ED	3 hour maintained, DALI / Self Test

For emergency version, add onto end of part number as required

Continuous Options

Code	Description
C	Continuous
S	Start of run
E	End of run

Part numbers are for individual luminaires. For continuous replace 'I' in part number with 'C', 'S' or 'E'. Please specify continuous separately. ie **P1CB/OS/F/3990/4K8**

Please note, The light source contained in this luminaire shall only be replaced by the manufacturer or his service agent or a similar qualified person.

Polaris 1 Hexagon

Linear LED Feature Pendant

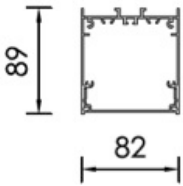
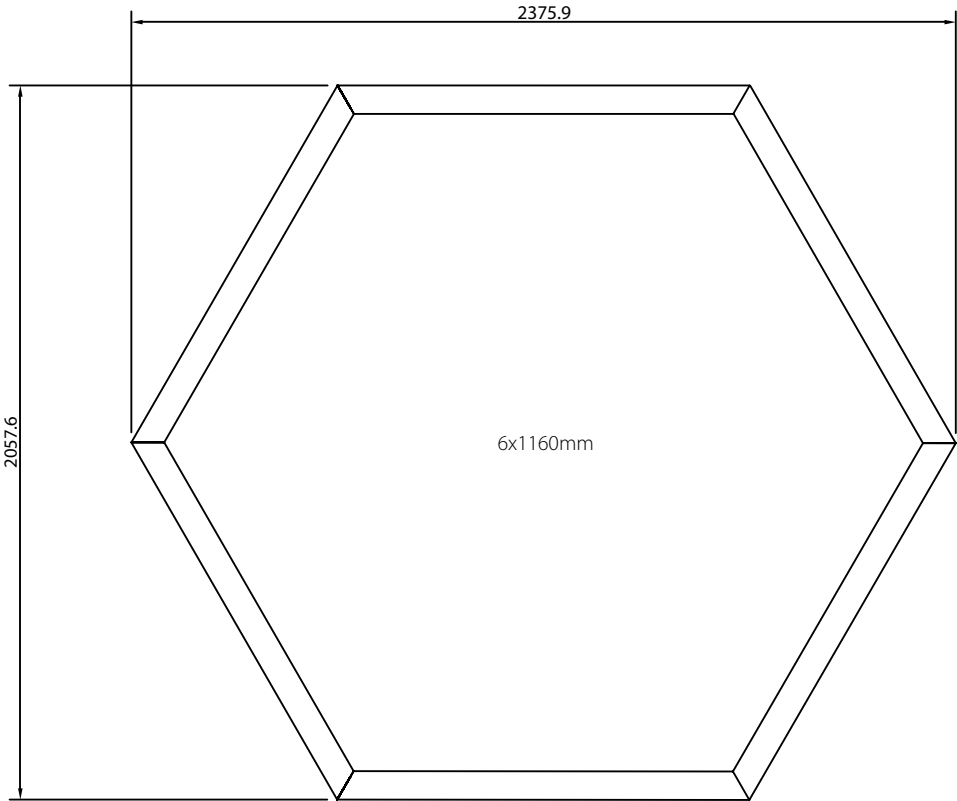
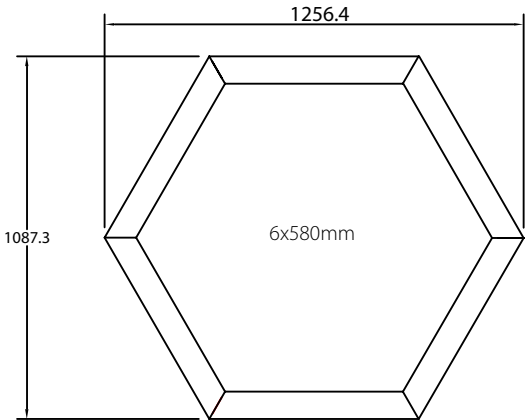
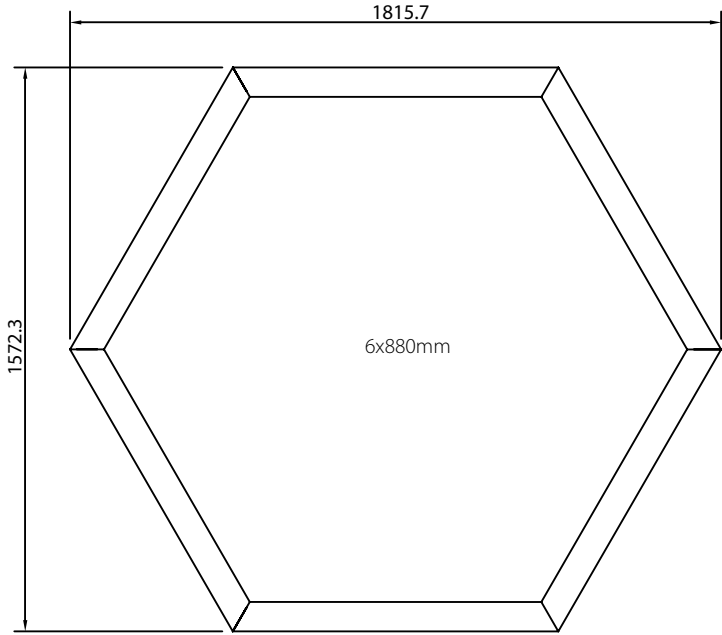
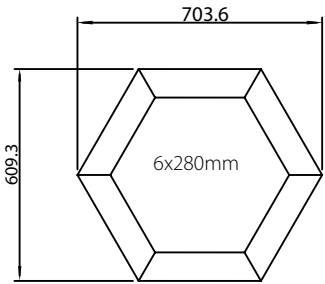

Polaris 1 Hexagon

Linear LED Feature Pendant

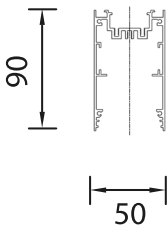
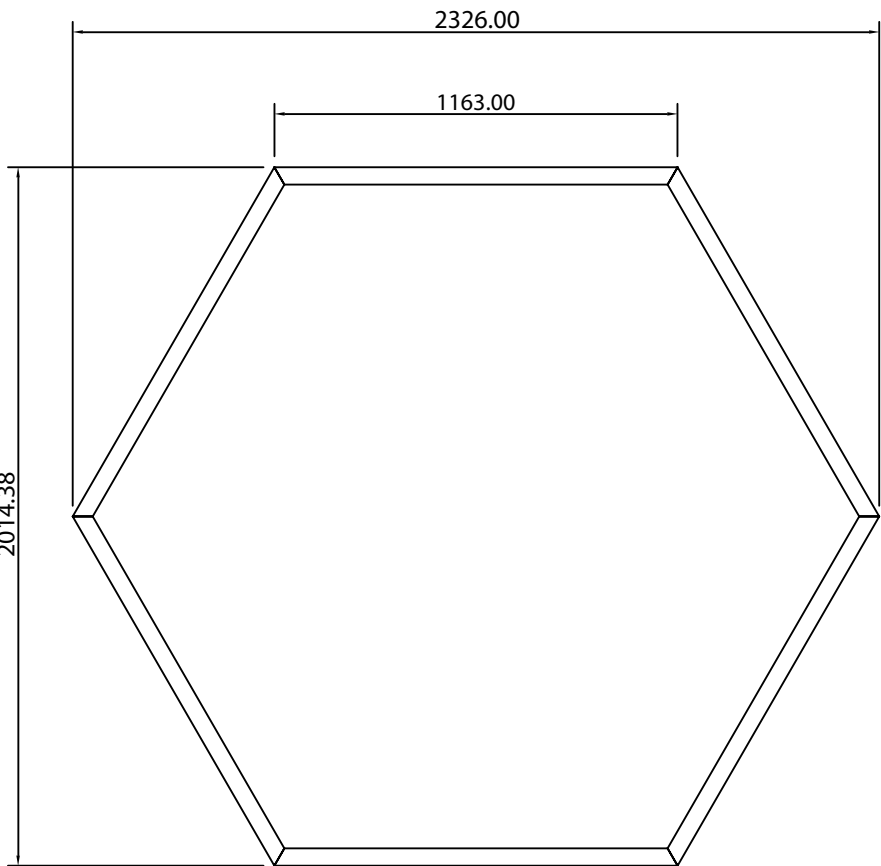
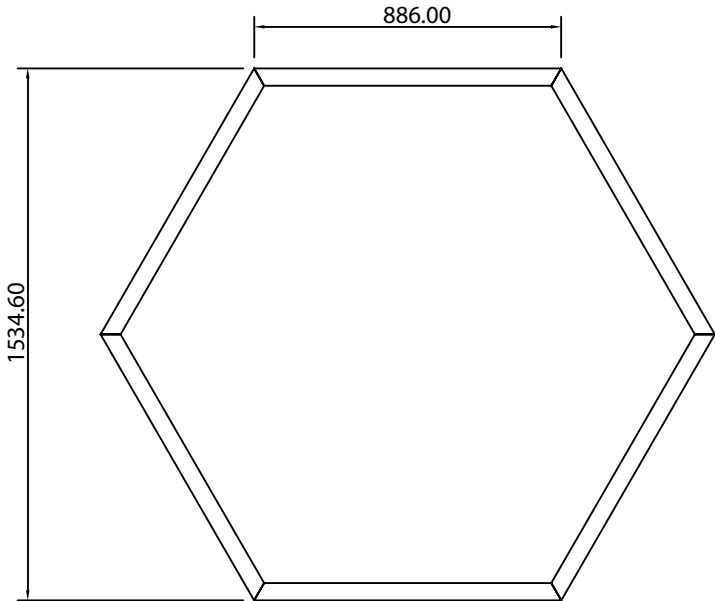
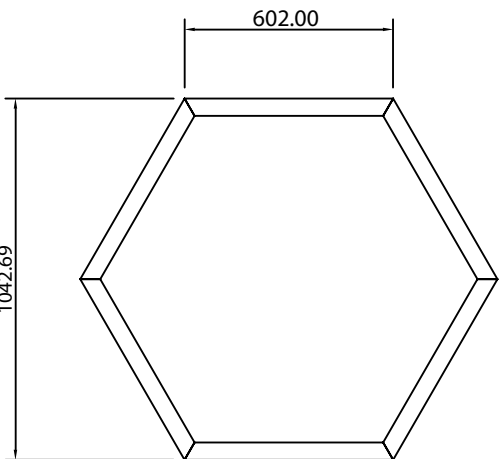
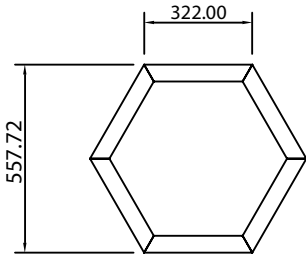

Polaris 1 Hexagon

Linear LED Feature Pendant



STANDARD FINISHES

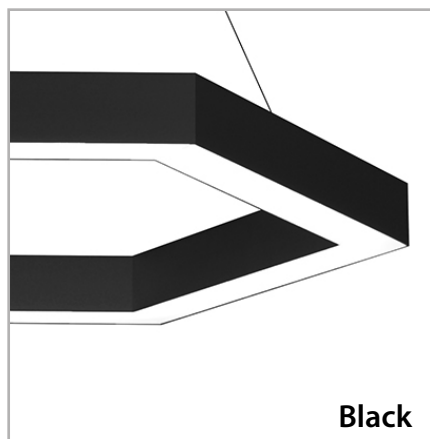

Black finish as standard - represented by 'B' in the part number

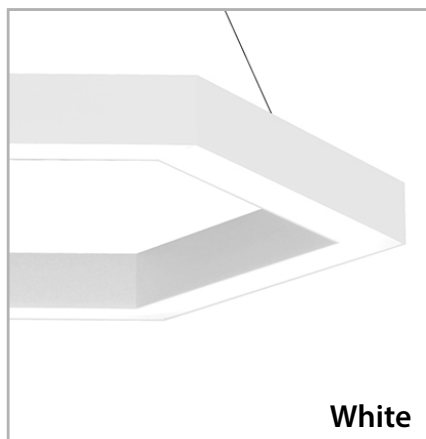

For White finish, replace 'B' in part number with 'W'

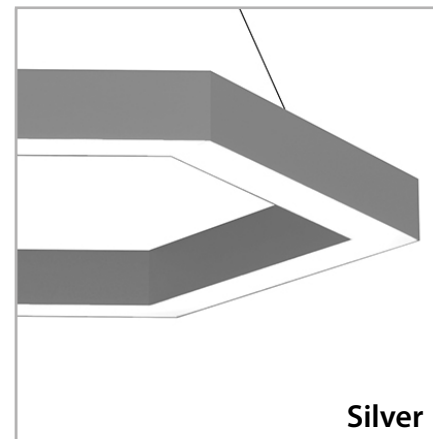

For Silver finish, replace 'B' in part number with 'S'

ANY RAL BY REQUEST

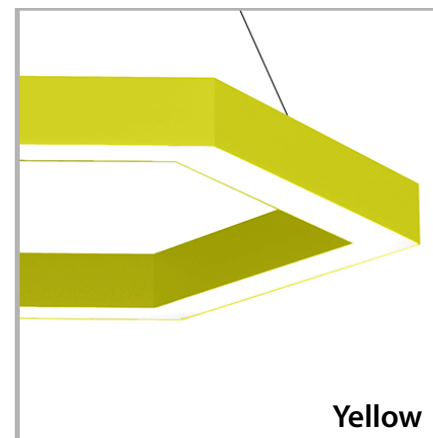
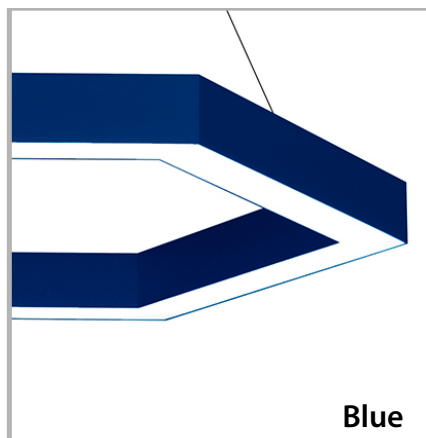
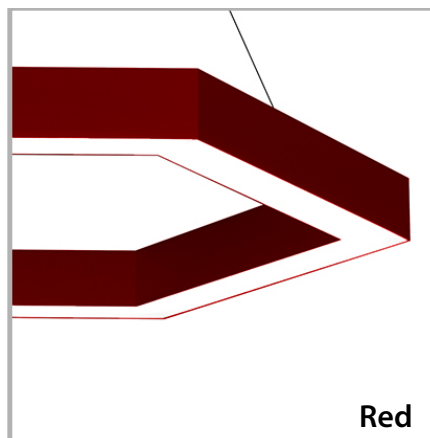

Contact us for custom RAL finishes prices and specification. Synergy Creativ can powder coat fittings to any RAL colour you require by request.

SPECIAL FX FINISHES

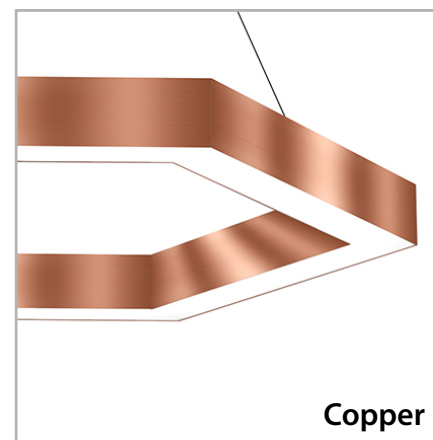
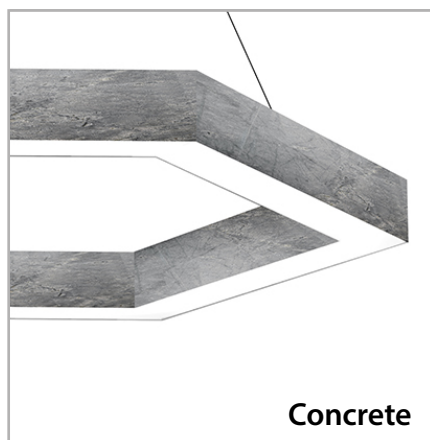

Contact us for all SFX finish prices and specification. Synergy Creativ's Special FX textured finishes include Marble, Concrete, Wood Grains, Metallic and many more. All images are for illustrative purposes only; actual product may vary, please contact us for samples.

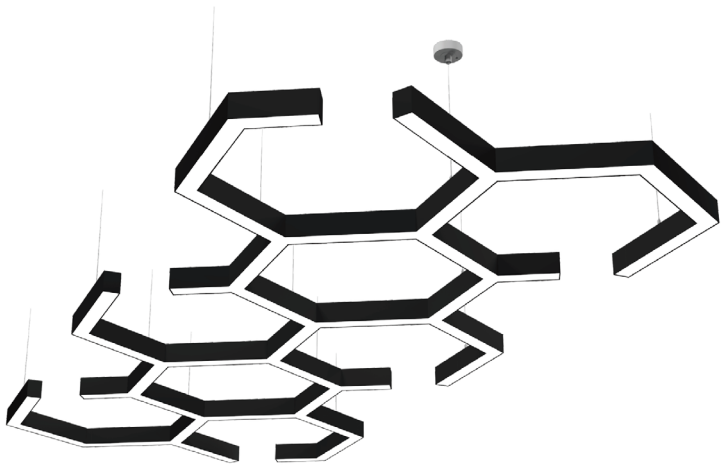

FULLY CUSTOMISABLE
**If you can
imagine it
Synergy Creativ
can make it**

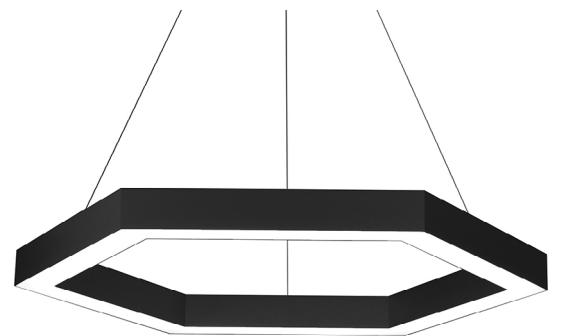
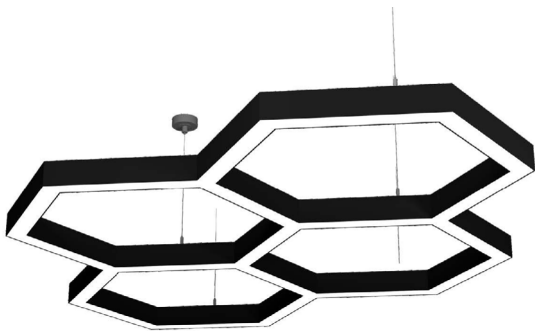

HEAD OFFICE: Unit 4, Charlton Mead Lane, Hoddesdon, Hertfordshire EN11 0DJ
SHOWROOM: 121-131 Rosebery Ave, London EC1R 4RF
SHOWROOM: 1 New York St, Manchester M1 4HD

01992 445828

Enabled
Licensing Program for LED
Luminaires and Retrofit Bulbs

Member
Synergy Commercial
Lighting Limited